

# The **NiceBar** System

New range of road barrier systems to control accesses in public and private parking areas, even where traffic is heavy.

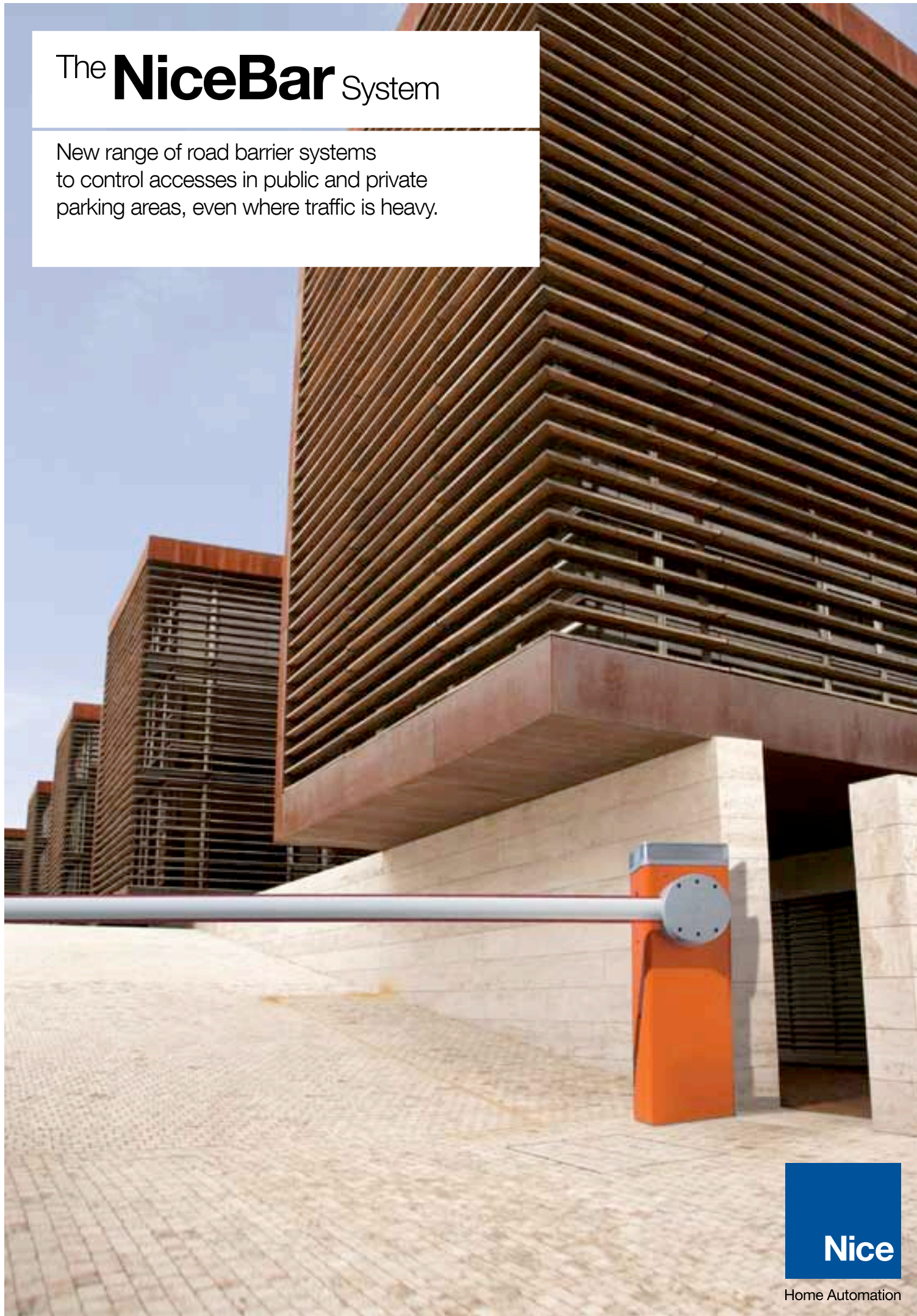

**Nice**

Home Automation







# **L/M/S Bar** **Barrier gate** **operators** **for all sizes**

**New range of barrier gate operators to control road access to car parks, private and condominial transit areas, including high traffic ones.**

**Powerful and fast: 5 models in 3 standard versions, up to 7 modular bars from 3 to 9 m.**

**Easy transport and optimised management in the warehouse.**





### Safe

Integrable flashing or traffic light.  
Nightlight function for on-site lighting. Vandal-proof thanks to the tough aluminium case.



# Nice Road Barrier

High performing, reliable and durable.  
Elegant, streamlined design.  
Carefully selected materials.  
Greater convenience, safety at all times.



### Solemyo System

Solemyo solar power kit for the automation of gates, garage doors and barriers even a long way from electricity supplies, with no need for expensive, unsightly trench digging.



### Opera System

For user-friendly, safe control, programming and monitoring of automation systems, with impressive time savings.



### BlueBUS

The BlueBUS system allows connection of all system devices using just two wires. Quick installation and easy updating at any time!

**Elliptical section bar  
with high resistance  
to gusts of wind.  
Led signal lights.**



### **User-friendly compact design**

Quick and easy access to internal components with separate enclosures for electronics and mechanics to protect from potential risks. The control unit, located in the upper part of the barrier body, can be reached by simple removing the cover.



### **Intelligent**

Photocells can be fitted in the specially designed seats in the inner part of the barrier body. Integrated loop detector management.



### **Power and reliability**

New high resistance balancing springs guarantee up to 1,000,000 operations. Powerful and fast 24 Vdc gearmotor. Maximum protection: steel housing with protective cataphoresis treatment and paint finish, also available in stainless steel version.



# Integrated solutions for all requirements





# Nice S/M/L Bar

## Guide to the selection and composition of bars and accessories

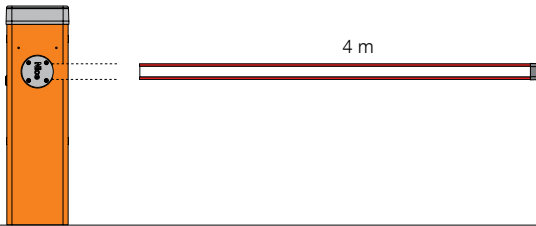

### SBAR

- **With specific 4 m bar**  
Provision for:  
protective rubber trim  
and indicator lights

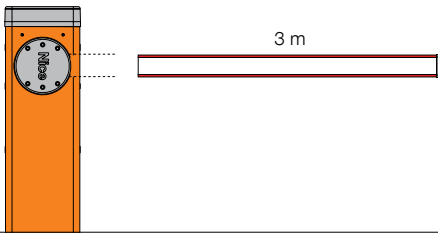

### M3BAR

- **With 3 m bar**  
Provision for:  
protective rubber trim  
and indicator lights

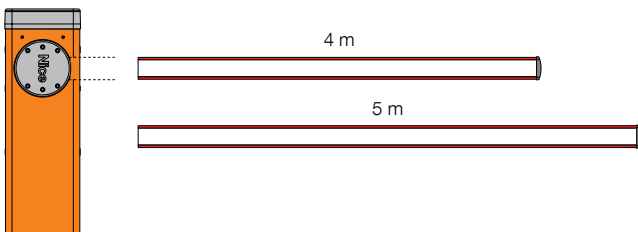

### M5BAR

- **With 4 m bar**  
Provision for:  
protective rubber trim,  
indicator lights,  
rack, mobile stand
- **With 5 m bar**  
Provision for:  
protective rubber trim  
and indicator lights

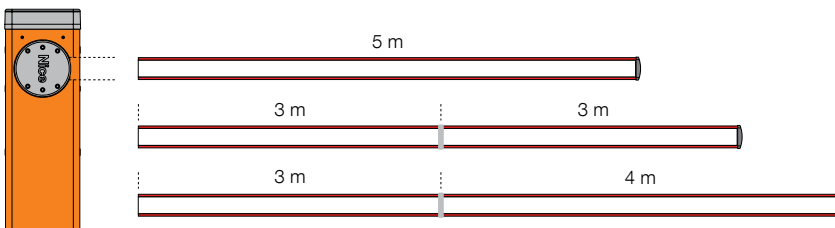

### M7BAR

- **With 5 m bar**  
Provision for:  
protective rubber trim, indicator lights,  
rack, mobile stand
  - **With bar up to 6 m (3+3 m)\***  
Provision for:  
protective rubber trim, indicator lights,  
rack, mobile stand
  - **With bar up to 7 m (3+4 m)\***  
Provision for:  
protective rubber trim  
and indicator lights
- \*Use **XBA9** joint to assemble bars

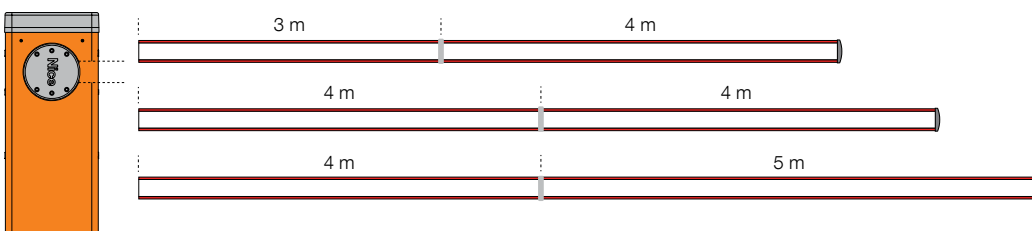

### LBAR

- **With bar of 7 m (3+4 m)\***  
Provision for:  
protective rubber trim, indicator lights,  
rack, mobile stand
  - **With bar of 8 m (4+4 m)\***  
Provision for:  
protective rubber trim, indicator lights,  
rack, mobile stand
  - **With bar of 9 m (4+5 m)\***  
Provision for:  
protective rubber trim  
and indicator lights
- \*Use **XBA9** joint to assemble bars

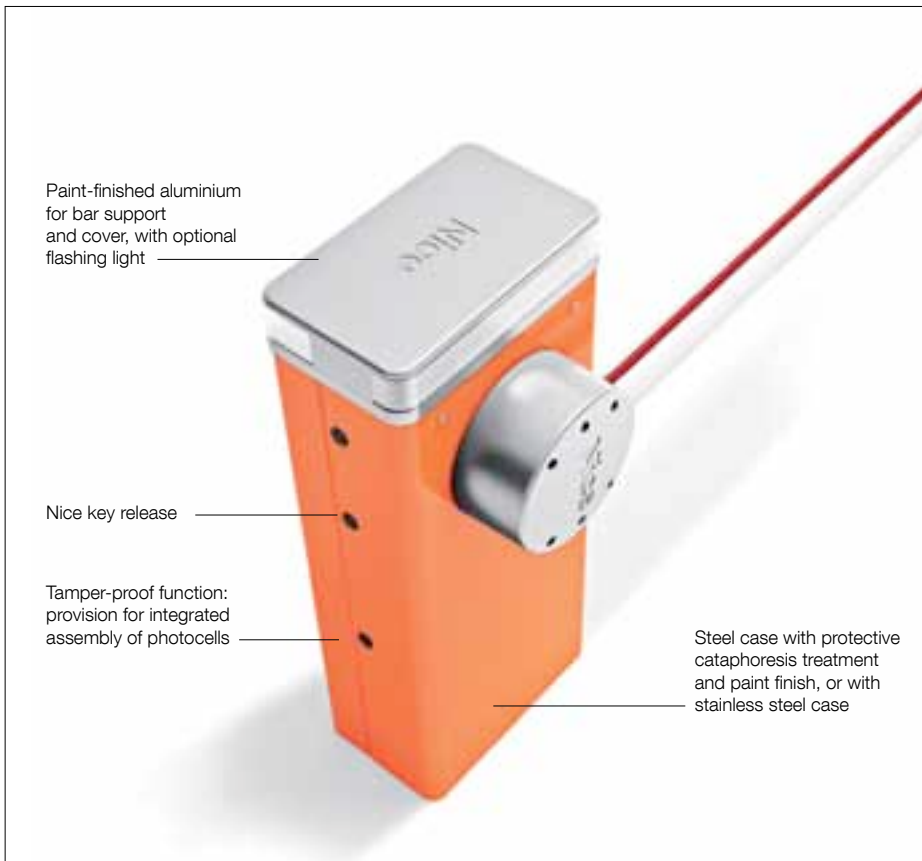

**Electromechanical road barrier system for control of road access.**  
24 Vdc gearmotor with built-in control unit and loop detector.

**Powerful and fast, for bars from 7 to 9 m.**

**Modular:** are easily assembled using the aluminium expansion joint.

Possibility for intelligent control of two opposing automations thanks to **“master/slave” function.**

**Strength and reliability:** robust structure in steel, new high strength balancing springs guaranteed up to 1,000,000 opening and closing operations and elliptical section bar with high wind-gust resistance.

Optional flashing or traffic light can be integrated in cover.

Encoder movement control and electromechanical limit switches.

**More comfort and safety in programming and maintenance phases:** the separate enclosures for electronics and mechanics protect internal parts from potential risks.

**Rapid and easy access** to the control unit located in the upper section of the barrier body.

Simple fixture of the completely concealed photocells onto the specially designed seats on the barrier body.

**More safety and reliability:** obstacle detection and monitoring of motor absorption during automation movement.

Automatic fault diagnostics during operation with consequent signalling of fault type through specific flash sequences.

Provision for connection of latest generation optical and resistive sensitive edges (with 8.2 KOhm resistance).

**Energy saving:** the system sets to standby when not in use to save consumption.

**No blackouts:** emergency backup power with the optional batteries housed inside the case.

**Release from side with metal key,** can be installed on either side.

**For bars up to 9 m,** irreversible 230 Vac, 24 Vdc motor, with foundation plate:

Code	Description
<b>LBAR</b>	With steel case with protective cataphoresis treatment and paint finish
<b>LBARI</b>	With stainless steel case

## Technical specifications

	LBAR	LBARI
<b>Code</b>		
<b>Electrical data</b>		
Power supply (Vac 50/60 Hz)	230	
Power supply (Vdc)	24	
Absorption (A)	1,3	
Power (W)	160	
<b>Performance data</b>		
Speed (s)	8 ÷ 12	
Torque (Nm)	400	
Work cycle (cycles/hour)	150	
<b>Dimensional and general data</b>		
Protection level (IP)	54	
Working temp. (°C Min/Max)	-20 ÷ +50	
Dimensions (mm)	500x299x1215 h	
Peso (kg)	98	



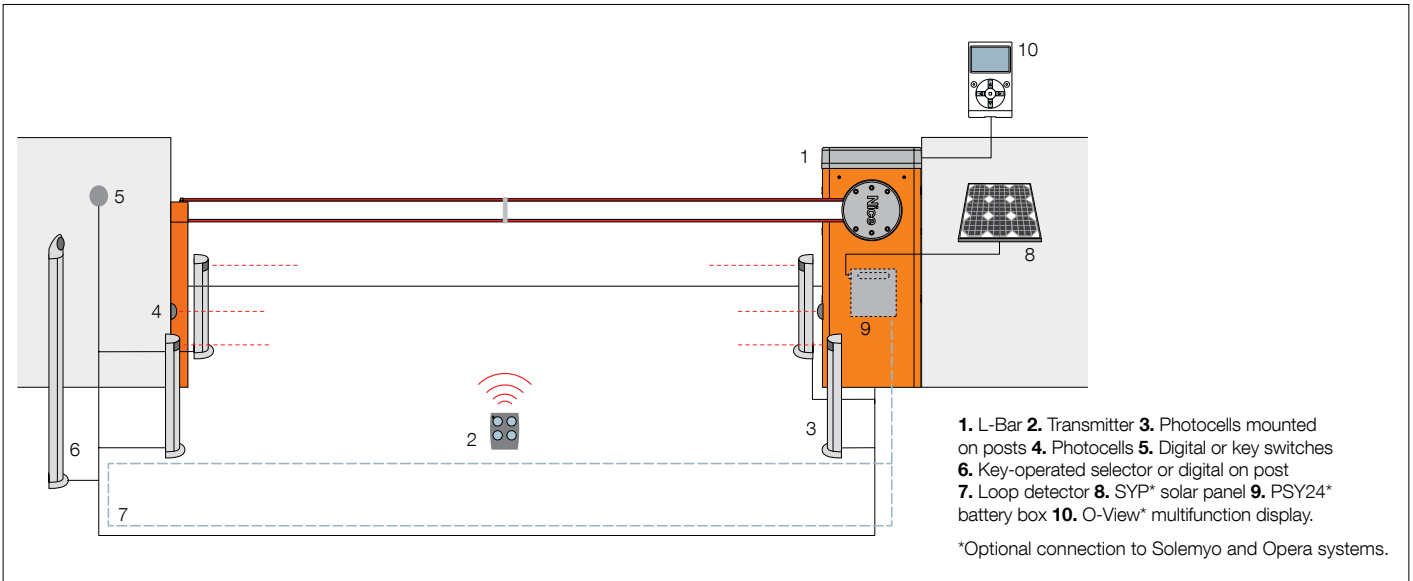

### Accessories

Code	Description	Pc/pack
<b>XBA3</b>	Spare control unit	1
<b>PS224</b>	24 Vdc buffer battery	1
<b>XBA15</b>	White paint-finished aluminium bar 69x92x3150 mm	1
<b>XBA14</b>	White paint-finished aluminium bar 69x92x4150 mm	1
<b>XBA5</b>	White paint-finished aluminium bar 69x92x5150 mm	1
<b>XBA9</b>	Expansion joint	1
<b>XBA13</b>	Rubber impact protection strip. Length 1 m	9
<b>WA10</b>	Red adhesive reflector strips	24
<b>XBA18</b>	Indicator lights for click fixture on upper or lower side of bar. Length 8 m	1
<b>XBA8</b>	Integrable traffic light	1
<b>XBA7</b>	Integrable flashing light	1
<b>WA13</b>	Aluminium rack up to 2 m	1
<b>XBA17</b>	Anchorage base with clamps, for LBAR	1
<b>WA12</b>	Mobile stand for bars - <i>New fully reinforced version</i>	1
<b>WA11</b>	Adjustable stand for bars	1

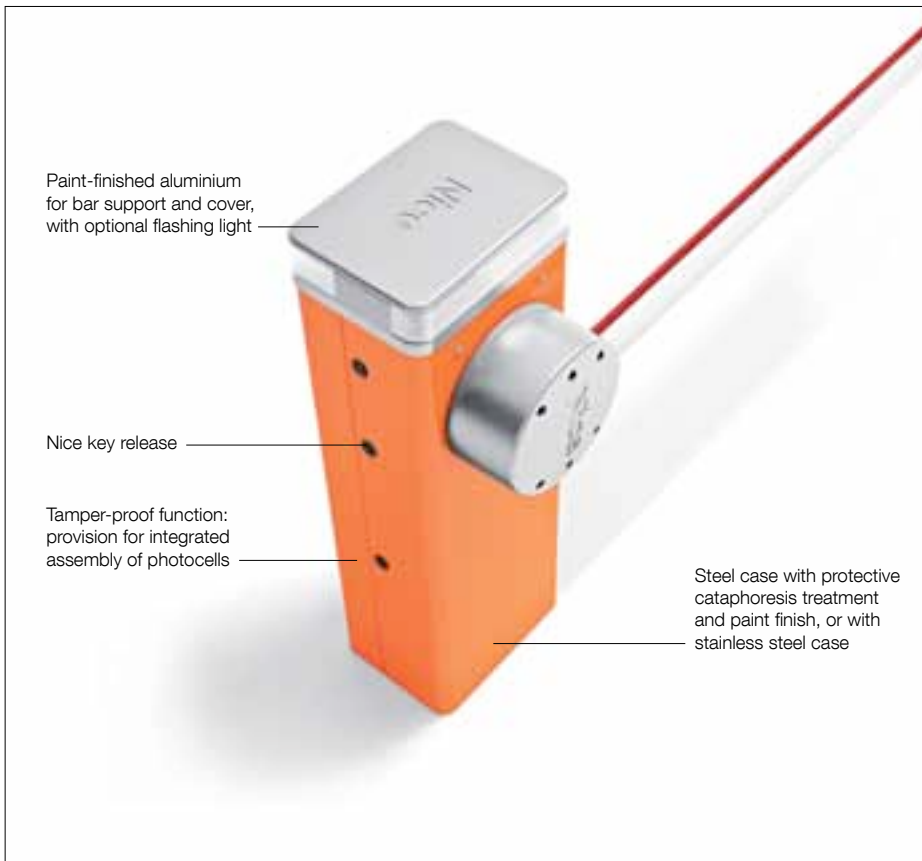

**Electromechanical road barrier system for control of road access.**  
24 Vdc gearmotor with built-in control unit and loop detector.

**For bars up from 3 to 7 m.**

**Modular:** are easily assembled using the aluminium expansion joint.

Possibility for intelligent control of two opposing automations thanks to **“master/slave” function.**

**Strength and reliability:** robust structure in steel, new high strength balancing springs guaranteed up to 1,000,000 opening and closing operations and elliptical section bar with high wind-gust resistance.

Optional flashing or traffic light can be integrated in cover.

Encoder movement control and electromechanical limit switches.

**More comfort and safety in programming and maintenance phases:** the separate enclosures for electronics and mechanics protect internal parts from potential risks.

**Rapid and easy access** to the control unit located in the upper section of the barrier body.

Simple fixture of the completely concealed photocells onto the specially designed seats on the barrier body.

**More safety and reliability:** obstacle detection and monitoring of motor absorption during automation movement.

Automatic fault diagnostics during operation with consequent signalling of fault type through specific flash sequences.

Provision for connection of latest generation optical and resistive sensitive edges (with 8.2 KOhm resistance).

**Energy saving:** the system sets to standby when not in use to save consumption.

**No blackouts:** emergency backup power with the optional batteries housed inside the case.

**Release from side with metal key,** can be installed on either side.

**With bar up to 3 m,** irreversible 230 Vac, 24 Vdc motor, with foundation plate:

Code	Description
<b>M3BAR</b>	With steel case with protective cataphoresis treatment and paint finish
<b>M3BARI</b>	With stainless steel case

**With bar up to 4 or 5 m,** irreversible 230 Vac, 24 Vdc motor, with foundation plate:

Code	Description
<b>M5BAR</b>	With steel case with protective cataphoresis treatment and paint finish
<b>M5BARI</b>	With stainless steel case

**With bar up to 5, 6 or 7 m,** irreversible 230 Vac, 24 Vdc motor, with foundation plate:

Code	Description
<b>M7BAR</b>	With steel case with protective cataphoresis treatment and paint finish
<b>M7BARI</b>	With stainless steel case

## Technical specifications

Code	M3BAR	M3BARI	M5BAR	M5BARI	M7BAR	M7BARI
<b>Electrical data</b>						
Power supply (Vac 50/60 Hz)	230					
Power supply (Vdc)	24					
Absorption (A)	1,3		1,1		1,1	
Power (W)	150		110		110	
<b>Performance data</b>						
Speed (s)	1,5 ÷ 4		3 ÷ 6		6 ÷ 10	
Torque (Nm)	100		200		300	
Work cycle (cycles/hour)	500		350		200	
<b>Dimensional and general data</b>						
Protection level (IP)	54					
Working temp. (°C Min/Max)	-20 ÷ +50					
Dimensions (mm)	400x299x1215 h					
Peso (kg)	80			85		



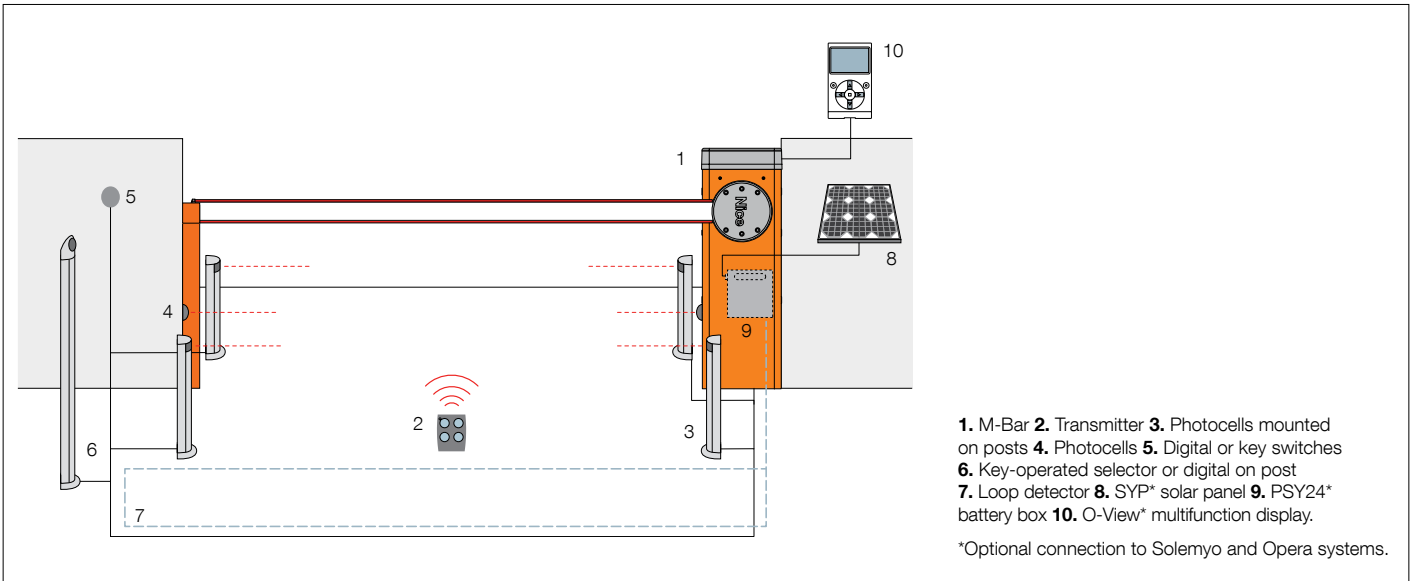

### Accessories for M3BAR, M5BAR, M7BAR

Code	Description	Pc/pack
<b>XBA3</b>	Spare control unit	1
<b>PS224</b>	24 Vdc buffer battery	1
<b>XBA13</b>	Rubber impact protection strip. Length 1 m	9
<b>WA10</b>	Red adhesive reflector strips	24
<b>XBA8</b>	Integrable traffic light	1
<b>XBA7</b>	Integrable flashing light	1
<b>XBA16</b>	Anchorage base with clamps, for MBAR	1
<b>WA11</b>	Adjustable stand for bars	1

### Accessories for M3BAR

Code	Description	Pc/pack
<b>XBA15</b>	White paint-finished aluminium bar 69x92x3150 mm	1
<b>XBA4</b>	Indicator lights for click fixture on upper or lower side of bar. Length 4 m	1
<b>XBA10</b>	Pivoting connection for bars up to 4 m	1
<b>XBA11</b>	Joint for bars XBA15	1

### Accessories for M5BAR

Code	Description	Pc/pack
<b>XBA14</b>	White paint-finished aluminium bar 69x92x4150 mm	1
<b>XBA5</b>	White paint-finished aluminium bar 69x92x5150 mm	1
<b>XBA4</b>	Indicator lights for click fixture on upper or lower side of bar. Length 4 m	1
<b>XBA6</b>	Indicator lights for click fixture on upper or lower side of bar. Length 6 m	1
<b>XBA10</b>	Pivoting connection for bars up to 4 m	1
<b>XBA11</b>	Joint for bars XBA14	1
<b>WA12</b>	Mobile stand for bars - <i>New fully reinforced version</i>	1
<b>WA13</b>	Aluminium rack up to 2 m	1

### Accessories for M7BAR

Code	Description	Pc/pack
<b>XBA15</b>	White paint-finished aluminium bar 69x92x3150 mm	1
<b>XBA14</b>	White paint-finished aluminium bar 69x92x4150 mm	1
<b>XBA5</b>	White paint-finished aluminium bar 69x92x5150 mm	1
<b>XBA9</b>	Expansion joint	1
<b>XBA6</b>	Indicator lights for click fixture on upper or lower side of bar. Length 6 m	1
<b>XBA18</b>	Indicator lights for click fixture on upper or lower side of bar. Length 8 m	1
<b>WA12</b>	Mobile stand for bars - <i>New fully reinforced version</i>	1
<b>WA13</b>	Aluminium rack up to 2 m	1

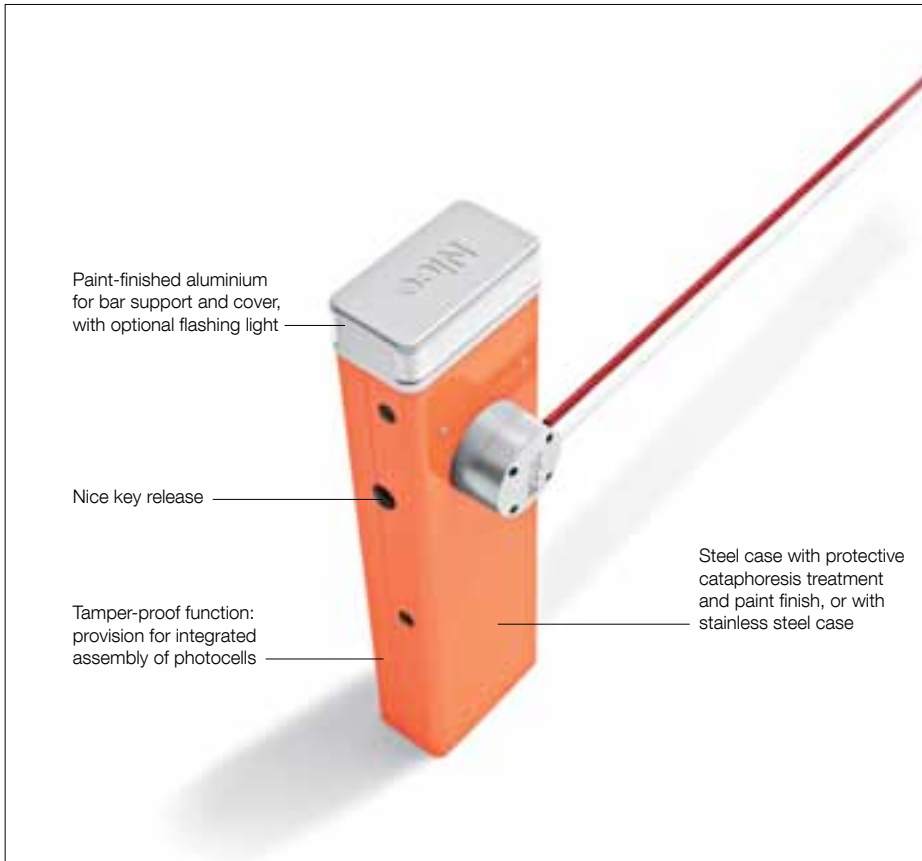

## Electromechanical road barrier system for control of road access.

24 Vdc gearmotor with built-in control unit.

**For bar up to 4 m.**

**Strength and reliability:** robust structure in steel, new high strength balancing springs guaranteed up to 1,000,000 opening and closing operations and elliptical section bar with high wind-gust resistance.

Optional flashing or traffic light can be integrated in cover.

**More comfort and safety in programming and maintenance phases:** the separate enclosures for electronics and mechanics protect internal parts from potential risks.

**Rapid and easy access** to the control unit located in the upper section of the barrier body.

Simple fixture of the completely concealed photocells onto the specially designed seats on the barrier body.

**More safety and reliability:** obstacle detection and monitoring of motor absorption during automation movement.

Automatic fault diagnostics during operation with consequent signalling of fault type through specific flash sequences.

Provision for connection of latest generation optical and resistive sensitive edges (with 8.2 KOhm resistance).

**Energy saving:** the system sets to standby when not in use to save consumption.

**No blackouts:** emergency backup power with the optional batteries housed inside the case.

**Release from side with Nice triangular key,** can be installed on either side.

**With bar up to 4 m,** irreversible 230 Vac, 24 Vdc motor, with foundation plate:

Code	Description
<b>SBAR</b>	With steel case with protective cataphoresis treatment and paint finish
<b>SBARI</b>	With stainless steel case

### Technical specifications

	SBAR	SBARI
<b>Electrical data</b>		
Power supply (Vac 50/60 Hz)	230	
Power supply (Vdc)	24	
Absorption (A)	1	
Power (W)	300	
<b>Performance data</b>		
Speed (s)	<4	
Torque (Nm)	100	
Work cycle (cycles/hour)	100	
<b>Dimensional and general data</b>		
Protection level (IP)	44	
Working temp. (°C Min/Max)	-20 ÷ +50	
Dimensions (mm)	330x180x1180 h	
Peso (kg)	46	



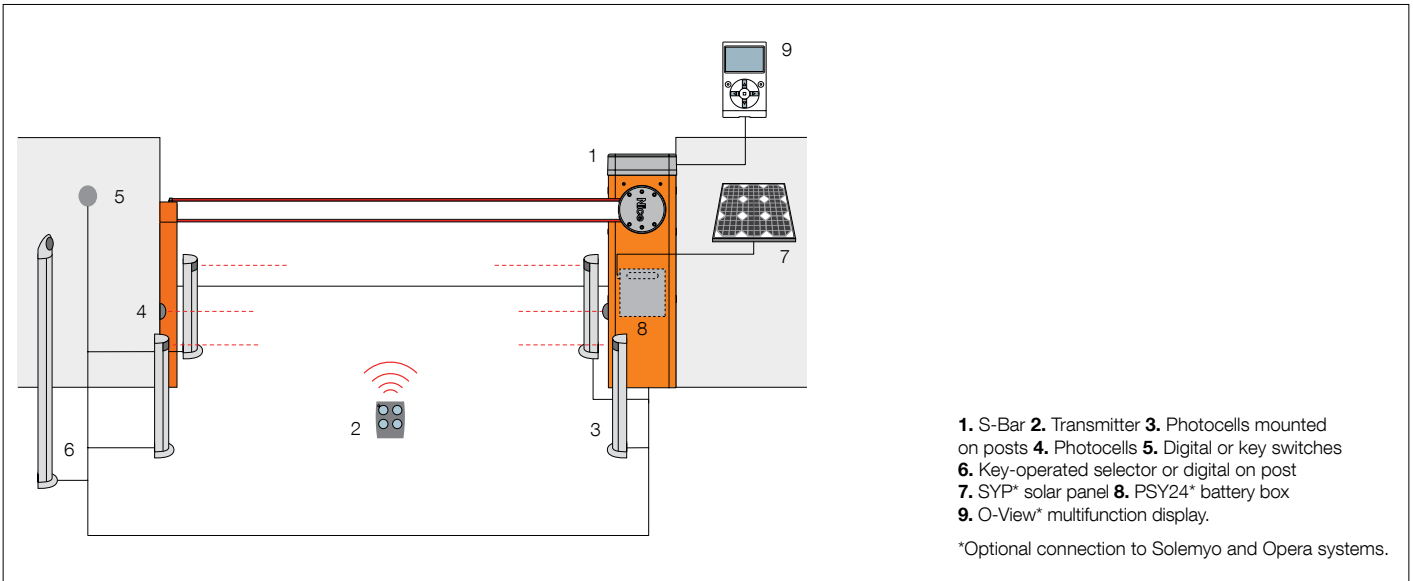

### Accessories

Code	Description	Pc/pack
<b>XBA20</b>	Spare control unit for SBAR	1
<b>PS124</b>	24 V battery with integrated battery charger	1
<b>XBA19</b>	White paint-finished aluminium bar 45x58x4000 mm	1
<b>XBA13</b>	Rubber impact protection strip. Length 1 m	9
<b>WA10</b>	Red adhesive reflector strips	24
<b>SIA1</b>	Anchorage base with clamps	1
<b>XBA7</b>	Integrable flashing light	1
<b>XBA4</b>	Indicator lights for click fixture on upper or lower side of bar. Length 4 m	1
<b>WA11</b>	Adjustable stand for bars	1

# Nice Opera Control, advanced management of automation systems also at a distance.

The innovative Opera system enables the installer to manage, program and control automation systems, also remotely, simply and safely, with significant savings in time.

**Nice Opera** simplifies the installer's work, making for easier programming, and enabling access to all control panel parameters to adapt the system to all requirements. No specific procedures needed for each product: single programming mode with intuitive menus, with no need to consult instructions.

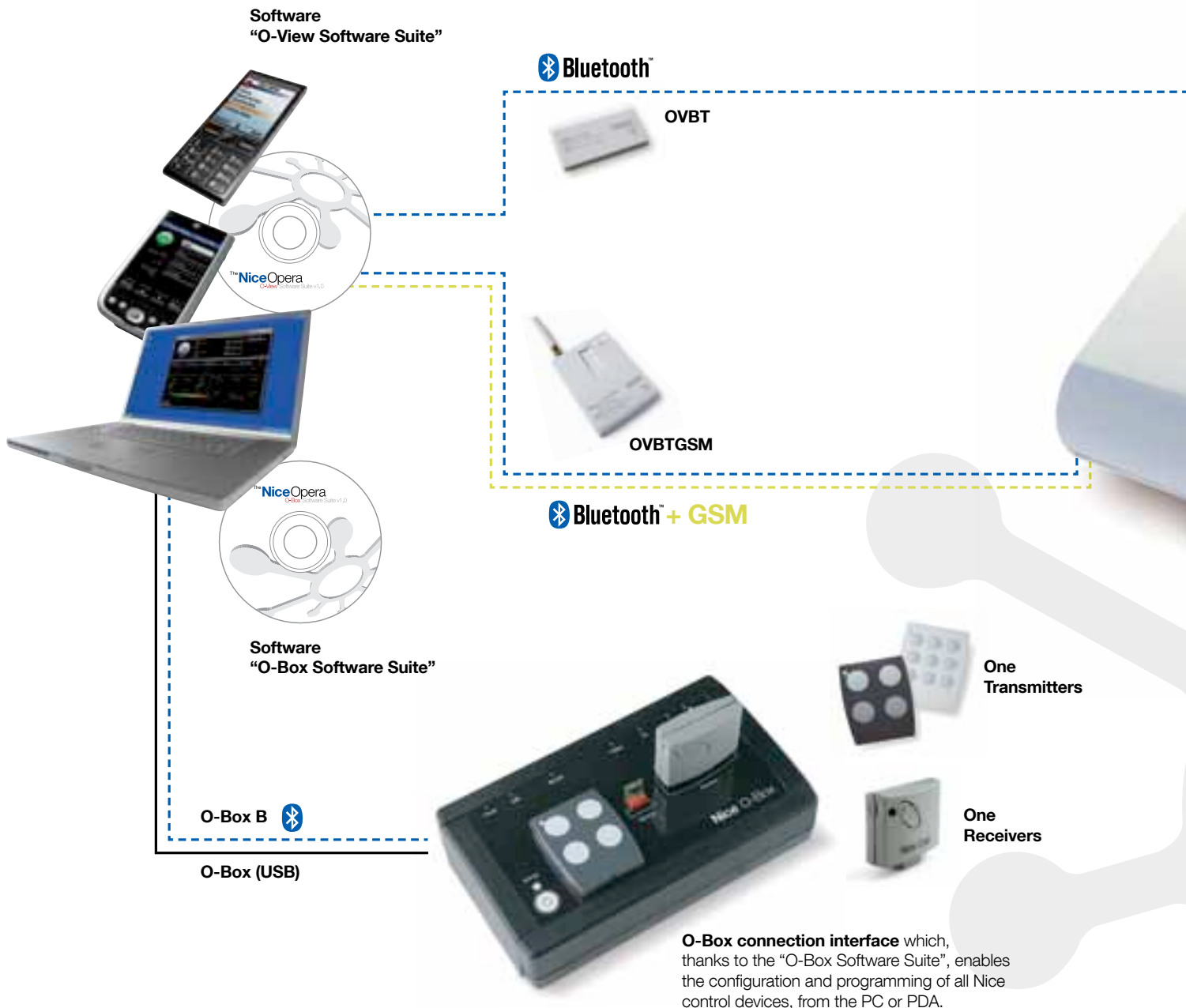



**Constantly efficient assistance for all customers:**

Simplifies system programming by means of the O-View multifunction display which when connected directly to the control panels compatible with the Opera system via BUS T4, enables full access to the system functions, for practical, rapid and advanced programming.

**BUS T4** is the innovative communication protocol that enables you to create extensive networks of compatible automation systems, managing them from a single point via O-View.

Device management can be protected by two password levels. By interfacing the system with the PC, you can control a complex automation system such as those found in densely frequented buildings (hospitals, hotels, companies, etc.).



<<< BUS T4

**O-View, multifunction display**  
Unit for control, programming and diagnostics for devices equipped with BUS T4 connection, on site or remotely via GPRS thanks to the connection with your PDA, Smartphone or PC.

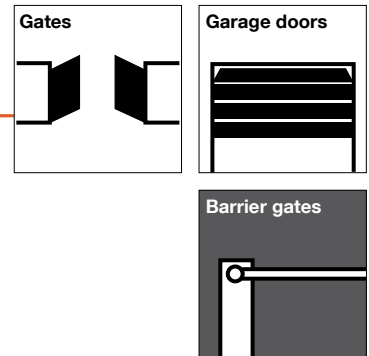

<<< BUS T4

**OX4T universal 4-channel receiver**  
with built-in transmitter. For remote control of any automation, irrigation and lighting systems or other electrical circuits.



**Nice Motors not designed for**

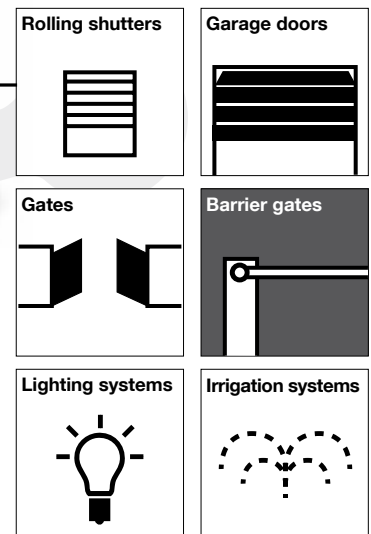

Opera

# The Nice Idea

Improving people's quality of life simplifying everyday's activities.

As one of the most important names in the field of Home Automation at international level, Nice develops, produces and merchandises alarm and automation systems for gates, garage doors, barrier gates, awnings, rolling shutters and solar screens for residential, commercial and industrial buildings.

Nice offers you the security to get in and out freely, satisfying your need for comfort with its functional and beautifully designed products, to allow you to fully enjoy your home.



NiceLoveEarth

Nice cares for the environment.  
Using natural paper it avoids excessive  
use of raw materials and forest exploitation.  
Waste is reduced, energy is saved  
and climate quality is improved.



**Nice**

**Nice SpA**  
Oderzo TV Italia  
Ph. +39.0422.85.38.38  
Fax +39.0422.85.35.85  
info@niceforyou.com

Find out more about Nice  
products and services on the website:  
[www.niceforyou.com](http://www.niceforyou.com)