

Nice

OXIBD

EAC
made in Italy



Radio receiver

EN - Instructions and warnings for installation and use

Nice

1

PRODUCT DESCRIPTION

OXIBD is a radio receiver designed for being installed on a control unit for automating gates, garage doors and road barriers.

⚠ – All uses other than the intended use described and use in environmental conditions other than those described in this manual should be considered improper and forbidden!

• **One-way and two-way radio communication**

In one-way radio communication, the two devices involved (equipped with one-way radio technology) have a clearly defined and unambiguous role within the system: there is a transmitter that simply transmits and a receiver that only receives without any further role. The radio communication, therefore, is one-way.

Instead in two-way communication, the two devices (equipped with two-way radio technology) play a different role each time within the system, as each one is capable of receiving and transmitting information from/to another device. Therefore, even the transmitters can turn into “receivers” of information coming from the receiver mounted in the control unit.

The OXIBD receiver has both the radio technologies, thus it can interface with both one-way and two-way transmitters.

Throughout this manual, “two-way” refers to the “two-way technology” of receiver-transmitter radio devices, while the term “BD” denotes a specific radio encoding protocol adopted by OXIBD and by transmitters featuring this encoding protocol.

“BD” encoding, unlike the other one-way encoding systems compatible with OXIBD (see further below), offers the following additional functions:

- the sending of the confirmation (on the transmitter) that the transmitted command was received;
- the sending of the status (on the transmitter) of the transmitter (for example, if the door, gate, etc., is open or closed).



• **Other product characteristics**

- The OXIBD receiver is compatible with the “O-Code”, “FloR”, “TTS”, “Smilo” and “Flo” one-way radio encoding systems, and with the “BD” two-way encoding system. In particular, the “O-Code” and “BD” encoding systems allow for exploiting all the advanced and exclusive functions of the “NiceOpera” system.
- The receiver, if it contains one-way transmitters only, can manage 1024 memory locations at the most: one location can alternatively memorise a single transmitter (if its keys are memorised as a “single set”, with the Mode 1 procedures – read Paragraph 3.1), or a single key (if memorised with the Mode 2 procedures – read Paragraph 3.2). If the receiver contains two-way transmitters only, a maximum of 750 two-way transmitters can be memorised.
- Each receiver has its own identification number, known as the “Certificate”. This allows for accessing several operations, such as, for example: the memorisation of new transmitters without having to access the receiver, and the use of the O-View programmer through its “BusT4” connection to the control unit.
- This receiver can be used solely with control units equipped with “SM”-type plug connector (verify the most suitable control units on the Nice product catalogue or on the www.niceforyou.com website).
- This receiver automatically recognises the characteristics of the control unit on which it is installed and self-sets in the following way:
 - If the control unit manages the “BusT4”, the receiver makes available up to 15 different commands.
 - If the control unit DOES NOT manage the “BusT4”, the receiver makes available up to 4 different commands.

Important! – In both cases, the number and diversity of the available commands depend on the type and model of the control unit adopted. The “Table of commands” of each control unit is shown in the respective instruction manual.

2 INSTALLATION AND CONNECTION

The receiver must be connected to the control unit by inserting it through the relevant slot:

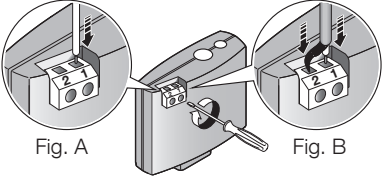
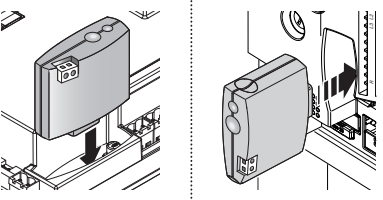
<p>01.  Before inserting (or removing) the receiver, disconnect the power supply to the control unit.</p>	<p>OFF</p> 
<p>02. Connect the <u>antenna supplied</u> to terminal 1 of the receiver, as shown in Fig. A. Alternatively, if the radio signal reception must be improved through the installation of an external antenna with a coaxial cable with 50Ω impedance (type RG58), the coaxial cable must be connected <u>directly to terminals 1 and 2 of the receiver (Fig. B)</u>, ignoring the “antenna” terminal (if present) on the control panel.</p>	 <p>Fig. A Fig. B</p>
<p>03. Insert the receiver through the relevant opening on the control unit.</p>	

04. Restore the power supply to the control unit.



3

MEMORISING / DELETING TRANSMITTERS IN THE RECEIVER

The first one-way transmitter to be memorised in the receiver also defines the **encoding system** (“O-Code” or “FloR” or “TTS” or “Smilo” or “Flo”) that each successive one-way transmitter to be memorised must have. Transmitters with “BD” encoding can instead be memorised freely, as they are compatible with one-way transmitters inside the receiver’s memory.

Each single coding allows for exploiting only the functions linked to that specific encoding system.

To verify to which encoding system the transmitters already memorised in the receiver belong, proceed as follows (Warning! – The receiver must already be connected to the control unit):

Verification of the TYPE OF ENCODING system adopted by the transmitters already memorised

01. Disconnect the power supply to the control unit and then restore the power.

LED B of the receiver will light up green first then orange. When the orange LED switches off, count the number of subsequent flashes:

- **1 green flash** = transmitters with O-Code or FloR or TTS encoding system
- **1 green flash and 1 orange flash** = transmitters with O-Code or FloR or TTS + BD encoding system

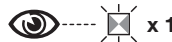
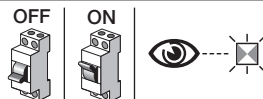

- **2 green flashes** = transmitters with O-Code or FloR or TTS encoding system
- **2 green flashes and 1 orange flash** = transmitters with O-Code or FloR or TTS + BD encoding system
- **3 green flashes** = transmitters with Smilo encoding system
- **3 green flashes and 1 orange flash** = transmitters with Smilo + BD encoding system
- **5 green flashes** = no transmitter memorised
- **5 green flashes and 1 orange flash** = transmitters with BD technology

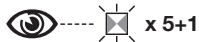
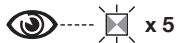
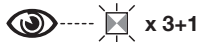
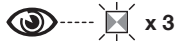
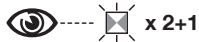
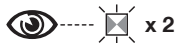







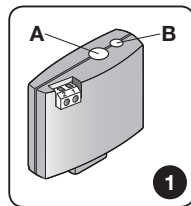

To change the coding assigned to the first one-way transmitter memorised, it is necessary to delete from the memory all the transmitters present (one-way and two-way), by strictly adopting Procedure 5 (Paragraph 3.6) and choosing the option, “ALL THE RECEIVER MEMORY”.







WARNINGS for carrying out the programming procedures

- During the execution of the **programming procedures**, refer to Fig. 1 to identify key A and LED B on the receiver.
- To understand the meaning of the icons featured in the procedure, refer to the table, “Key to the symbols used in the manual”.
- The procedures have a limit time; therefore, before implementing them, it is important to read and understand all the steps to be completed.

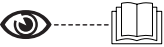

KEY TO THE SYMBOLS USED IN THE MANUAL

Symbol	Description
	(on the receiver) LED "B" STEADY LIT
	(on the receiver) LED "B" LONG FLASH
	(on the receiver) LED "B" QUICK FLASH
	(on the receiver) LED "B" OFF
<div style="display: flex; justify-content: space-around; align-items: center;"> <div style="text-align: center;"> <p>OFF</p>  </div> <div style="text-align: center;"> <p>ON</p>  </div> </div>	Disconnect power supply / Restore power supply
	Wait ...
> 5 sec <	Perform the operation within 5 seconds ...
	Hold down key "A" of the receiver



	Press and release key "A" of the receiver
	Release key "A" of the receiver
	Press and release the desired transmitter key
	Hold down the desired transmitter key
	Release the desired transmitter key
	Read the control unit's instruction manual
	Observe when LED "B" emits signals

The system can be programmed in Mode 1 or in Mode 2: see Paragraphs 3.1 and 3.2.

3.1 - Memorisation in "Mode 1"

While Procedure 1 is being carried out, the receiver memorises all the keys present on the transmitter, automatically assigning command 1 of the receiver to the 1st key, command 2 to the 2nd key, and so forth. Once the

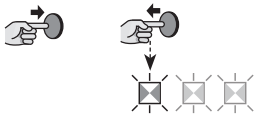

procedure terminates, the memorisation will occupy a single memory location and the command associated with each key will depend on the “List of commands” present on the automation’s control unit.

PROCEDURE 1 - Mode 1 memorisation	
<p>01. On the receiver: hold down key A and wait for the green LED B to light up. Subsequently, release key A.</p>	
<p>02. On the transmitter being memorised:</p> <ul style="list-style-type: none"> • <u>If the transmitter is a one-way device:</u> (within 10 seconds) on the transmitter: <u>hold down</u> any key and release it once LED B (on the receiver) emits the 1st of 3 green flashes (=memorisation completed correctly). (*1) 	
<ul style="list-style-type: none"> • <u>If the transmitter is a two-way device:</u> (within 10 seconds) on the transmitter: <u>press and immediately release</u> any key; LED B (on the receiver) will flash green 3 times (=memorisation completed correctly). (*1) 	
<p>(*1) Note - If there are other transmitters to be memorised, repeat step 02 within the next 15 seconds after the first 10. The procedure will terminate automatically once this time elapses.</p>	

3.2 - Memorisation in “Mode 2”

While Procedure 2 is being carried out, the receiver memorises a single key among those present on the transmitter, associating it with the receiver output chosen by the installer. To memorise further keys, repeat the procedure from the beginning for each key to be memorised. Once the procedure terminates, the memorisation will occupy a single memory location and the command associated with the memorised key will be that chosen

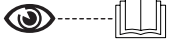
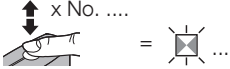
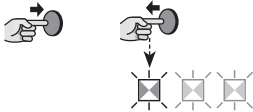
by the installer from the “List of commands” of the automation’s control unit. **Note** - A key can be associated with only one output, while the same output can be associated with multiple keys.

PROCEDURE 2 - Mode 2 memorisation (and extended Mode 2)	
01.	<p>In the control unit manual: choose the command to be memorised and remember its “identification number”.</p> 
02.	<p>On the receiver: press and release key A for a number of times matching the <u>number that identifies the command chosen at step 01</u>: LED B will flash the same number of times.</p> 
03.	<p>On the transmitter with the key to be memorised:</p> <ul style="list-style-type: none"> • <u>If the transmitter is a one-way device:</u> (within 10 seconds) on the transmitter: <u>hold down</u> the key to be memorised and release it once LED B (on the receiver) emits the 1st of 3 green flashes (=memorisation completed correctly). (*2)  <ul style="list-style-type: none"> • <u>If the transmitter is a two-way device:</u> (within 10 seconds) on the transmitter: <u>press and immediately release</u> the key to be memorised; LED B (on the receiver) will flash green 3 times (=memorisation completed correctly). (*2) 
<p>(*2) Note - If there are other keys to be memorised (belonging to other transmitters) <u>with the same command</u>, repeat step 03 within the next 15 seconds for each further key to be memorised (the procedure terminates once this time elapses).</p>	



3.3 - Memorising a new transmitter “near the receiver” - only for one-way transmitters

This procedure allows for memorising a new transmitter by means of a second functioning transmitter, already memorised in the same control unit. This enables the new transmitter to receive the same settings as the

transmitter already memorised. The procedure does not entail any direct action on key A of the receiver, only the presence of the transmitter within the receiver's reception range.

- The memorisation “near the receiver” can be prevented by blocking the receiver's function through Procedure 7 (Paragraph 3.8). Alternatively, the receiver can also be blocked with the O-Box programmer.

PROCEDURE 3 - Memorising a new transmitter “near the receiver”

01.	On the NEW transmitter: <u>hold down</u> the key to be memorised; wait at least <u>7 seconds</u> then release it.	
02.	On the transmitter ALREADY MEMORISED: <u>slowly press and release 3 times</u> the memorised key to be copied.	
03.	On the NEW transmitter: <u>press and release once</u> the same key pressed at step 01.	

If there are other transmitters to be memorised, repeat the procedure from the beginning for each new transmitter.

3.4 - Memorising a new transmitter using the “enabling code” of an old transmitter already memorised in the receiver - only for transmitters with “O-Code” and “BD” encoding system

The memory of transmitters with O-Code and BD encoding contains an “enabling code” (secret) which can be used to enable a new transmitter to be memorised in the receiver. To perform this enabling procedure, read the transmitter's instruction manual and get an old transmitter already memorised in the same receiver in which the new transmitter is to be memorised. Warning! - The enabling code can only be transferred between two identical transmitters that have the same radio coding.

Subsequently, when the new enabled transmitter will be used, it will send to the receiver (in the first 20 transmis-

sions) the command, its own identification code and the “enabling code” received. At this point, the receiver will recognise the enabling code of the old transmitter and automatically memorise the identification code of the new transmitter.

- The undesired memorisation of transmitters through the “enabling code” can be prevented by blocking the receiver’s function through Procedure 7 (Paragraph 3.8). Alternatively, the receiver can be blocked also with the O-Box programmer, by intervening on the receiver or on the transmitters already memorised.

3.5 - Memorising (in the receiver) the control unit Series/Address, for the BusT4 network

The OXIBD receiver can interact with a single control unit through the “BusT4” network. If the system contains multiple control units connected to each other via “BusT4”, before carrying out the following procedure the cable of the “BusT4” network must be disconnected from the control unit on which the Series/Address will be memorised.

PROCEDURE 4 - Memorising (in the receiver) the control unit Series/Address, for the BusT4 network

01. Disconnect the power supply and wait 5 seconds.



- 02.** Hold down key A of the receiver and simultaneously restore the power supply:
LED B will flash a few times to signal the type of encoding system of the memorised transmitters (Chapter 3); it will then emit 2 short orange flashes; lastly, when the steady green light appears **(*3)**, release key A.

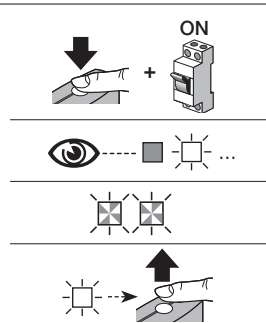

(*3) Note - If the LED emits a steady red light, it means that the memorisation procedure was not completed. In this case, repeat the procedure from the beginning.

⚠ WARNING! - Once the Series/Address has been memorised, the receiver will drive the control unit only through BusT4. The Stand-By function cannot be active on the control unit. To enable the Stand-By function on the control unit, do not run the “Memorising the control unit Series/Address for the BusT4 network” procedure.

⚠ WARNING! - To ensure correct management of the status on two-way transmitters (ON3EBD), the OXIBD receiver must have the same Series as the control unit.

3.6 - Deleting the receiver's memory (fully or partially)

In a one-way system, the memorisation or code deletion procedures involve the receiver alone. The one-way transmitter transmits a single command, and it is the receiver that must recognise whether or not the transmitter

is authorised to enable the automation.

The two-way transmitter, after the sending of a command, becomes itself a “receiver” of information coming from the associated receiver.

With the memorisation of two-way transmitters in the OXIBD receiver, the identification code of the same receiver is automatically memorised by the transmitter. Warning! - if the two-way transmitter in the OXIBD receiver is deleted, to complete the operation it is necessary to also delete the transmitter’s memory. To perform this procedure, consult the transmitter’s instruction manual.

PROCEDURE 5 - FULL or PARTIAL deletion of the receiver’s memory

01. **On the receiver:** hold down key A and observe the status of the green LED B: after 6 seconds it will light up then switch off. After a few seconds it will start flashing; then immediately choose the type of desired deletion:
- > **to delete ALL the transmitters:** release key A exactly at the **3rd flash**
- > **to delete ALL THE RECEIVER’S MEMORY:** release key A exactly at the **5th flash**
- > **to delete (in the receiver) the control unit’s Series/Address, for the BusT4 network:** release key A exactly at the **7th flash**



This function can be performed also using the O-Box / O-View programmers.

3.7 - Deleting a SINGLE transmitter or a SINGLE key from the receiver memory

PROCEDURE 6 - Deleting a SINGLE transmitter or a SINGLE key from the receiver memory

01. **On the receiver:** hold down key A, observe the green LED B light up and move to step 02 when it switches off.



02. **On the transmitter to be deleted:**

- If the transmitter is a one-way device:
(on the transmitter) hold down the key (*4) to be deleted and release it after LED B (on the receiver) has emitted the 1st of 5 quick green flashes (= deletion completed correctly).



- If the transmitter is a two-way device:
(on the transmitter) press and release the key to be deleted (*4): LED B (on the receiver) will emit 5 quick green flashes (= deletion completed correctly).



(*4) Note - If the transmitter is memorised in “Mode 1”, any key can be pressed. If the transmitter is memorised in “Mode 2”, the entire procedure must be repeated for each memorised key that must be deleted.

This operation can also be performed through the O-Box / O-View programmers.

3.8 - Locking (or release) of memorisations carried out with the “near the control unit” procedure and/or through the “enabling code”

This function prevents the memorisation of new transmitters in the receiver, when using the “near the receiver”

procedure (Paragraph 3.3) or the “enabling code” procedure (Paragraph 3.4). The default setting is ON for both procedures. To perform the following procedure it is necessary to have a transmitter already memorised in the receiver.



PROCEDURE 7 - Locking (or release) of memorisations carried out with the “near the control unit” procedure and/or through the “enabling code”

01. Disconnect the power supply and wait 5 seconds.

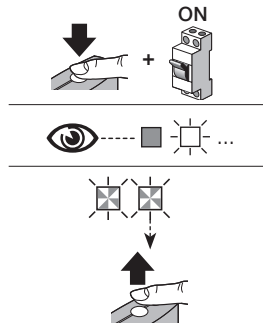

02. Hold down key A of the receiver and simultaneously restore the power supply: LED B first emits the signals relative to the memorised transmitters (Chapter 3) then emits a few short orange flashes: release key A exactly at the end of the 2nd orange flash.



<p>03. Within 5 seconds: repeatedly press and release key A of the receiver to choose one of the following functions, identifiable by the status of LED B:</p> <ul style="list-style-type: none"> - <u>No lock active</u> = LED OFF - <u>Locking of the memorisation “near the control unit”</u> = RED LED - <u>Locking of the memorisation with the “enabling code”</u> = GREEN LED - <u>Locking of both memorisations</u> (“near the control unit” and with “enabling code”) = ORANGE LED 	<p>> 5 sec <</p> 
<p>04. Within 5 seconds: <u>on a transmitter already memorised in the receiver</u>, press and release a key (memorised) to save the function that has just been chosen</p>	<p>> 5 sec <</p> 
<p>This function can be performed also using the O-Box / O-View programmers.</p>	

4 OTHER FUNCTIONS

4.1 - Locking (or releasing) the management of the “Priority” function in the receiver

The “identification code” of a transmitter with “O-Code” or “BD” encoding system is accompanied by a number (from **0** to **3**) that allows for defining (in the receiver) its **priority level** with respect to any other transmitters with the same code. The “priority” is aimed at replacing and disabling the use of a lost or stolen transmitter, without having to go to the customer’s system. Use of the priority function requires knowledge of the lost transmitter code and allows for keeping the same code and functions of the previous transmitter. The lost transmitter can therefore be deactivated by simply updating the **priority level** of the new transmitter to the next highest value.

When the transmitter is used for the first time, the receiver will memorise the **new priority level received** and ignore any command sent by the lost or stolen transmitter, should it be used. The priority can be changed through the O-Box programmer.

By default the receiver has the “Priority” function enabled, so the installer can exploit its potential applications. Nonetheless, the O-Box programmer can be used to lock (or release) the receiver in managing this function.

4.2 - Enabling (or disabling) reception of the transmitter codes, modified with respect to the default code

The codes of transmitters with “FloR” and “O-Code” encoding system can be modified as desired using the O-Box or O-View programmer. By enabling or disabling this function, the receiver can accept or refuse the command of a transmitter with modified identification code (the default setting is ON).

4.3 - Disabling (or enabling) the “variable part” (rolling code) of the code received

The receiver is programmed by default to only receive “rolling code”-type codes. The O-Box programmer, however, can be used to programme the receiver so that it ignores the variable part (rolling code) of the code received and considers it as a “fixed”-type code.

4.4 - “Transmitter keys release” function” (only with O-Code encoding)

During normal use of the transmitter, when a pressed key is released the automation’s manoeuvre continues for a short pre-set time. If the manoeuvre must be interrupted exactly when the key is released (for example, to perform a minor adjustment), this function must be enabled in the receiver through the O-Box programmer. This function is disabled by default.

4.5 - Enabling (or disabling) the receivers to send/receive radio commands through the BUST4 network that connects two or more automations

If one of the automations in systems containing multiple automations connected through the “BusT4” must be commanded from a distance exceeding the radio range of the transmitter-receiver system, this function can

be enabled in the receivers involved to increase their reception range. In this way, the receiver that received the command via radio can retransmit it through the BusT4 cable to the destination receiver (in which the identification code of the transmitter that sent the command is memorised), so that the latter can execute the command. This function is disabled by default. To enable (or disable) the repetition and/or reception of the code via BusT4, programme the relevant receivers appropriately through the O-View and O-Box programmers.

4.6 - Blocking access (through password) to the receiver programming

This function activates in the receiver (with the O-Box / O-View programmer) a password consisting of maximum 10 characters, chosen by the installer. The function allows for protecting all the settings already effected in the receiver; moreover, it also prevents any subsequent settings through key A of the receiver (Fig. 1) or through the O-Box and O-View programmers, if the password is not known.

5 TECHNICAL SPECIFICATIONS

OXIBD	
Product type	Two-way receiver
Decoding	OXIBD: "BD" / "O-Code" / "FloR" / "TTS" / "Flo" / "Smilo"
Input impedance	50 Ω
Reception frequency	433.92 MHz
Transmission frequency	433.92 MHz (only BD)
Outputs	4 (on "SM" plug-type connector)
Sensitivity	-108 dBm

Absorption	50 mA (maximum)
Radiated power	< 10 mW E.R.P.
Dimensions (mm)	W 49.5; H 41.9; D 18
Weight (g)	22
Operating temperature	-20 °C ... +55 °C

• Notes on the product technical specifications

- The reception capacity of the receivers and the transmitter range are strongly affected by other devices (e.g. alarms, headphones, etc.) operating on the same frequency in your area. Nice cannot provide any guarantee with regard to the actual range of its devices under such conditions.
- All technical specifications stated herein refer to an ambient temperature of 20°C ($\pm 5^\circ \text{C}$).
- Nice reserves the right to apply modifications to the product at any time when deemed necessary, without altering the intended use and functions of the product itself.

6

PRODUCT DISPOSAL

This product constitutes an integral part of the automation and, therefore, must be disposed of together with it.

Similarly to the installation phase, once the product reaches the end of its useful life, the disassembly and scrapping operations must be performed by qualified personnel. This product is made of various types of materials, some of which can be recycled while others must be scrapped. Seek information on the recycling and disposal systems envisaged by local regulations in your area for this product category.

 WARNING! - Some parts of the product may contain polluting or hazardous substances which, if released into the environment, constitute serious environmental and health risks.

As indicated by the adjacent symbol, the product may not be disposed of together with domestic waste. Sort the materials for disposal, according to the methods envisaged by current legislation in your area, or return the product to the retailer when purchasing an equivalent product.



⚠ WARNING! - Local regulations may envisage the application of heavy fines in the event of improper disposal of this product.

SIMPLIFIED EU DECLARATION OF CONFORMITY

Hereby Nice S.p.A. declares that the radio equipment type OXIBD is in compliance with Directive 2014/53/EU.

The full text of the EU declaration of conformity is available at the following internet address:

<https://www.niceforyou.com/en/support>

Signals emitted by LED B of the receiver**Long flashes > GREEN****On start-up:**

- 1 * = Current encoding system: "Flo"
- 2 * = Current encoding system: "O-Code"/"FloR"
- 3 * = Current encoding system: "Smilo"
- 5 * = No remote control memorised

During operation:

- 1 * = Indicates that the code received is not stored in the memory
- 3 * = Saving code in memory
- 5 * = Memory deleted
- 6 * = During programming, indicates that the code is not authorised for memorisation
- 8 * = During programming, indicates that the memory is full

Short flashes > GREEN

- 1 * = "Certificate" not valid for memorisation
- 2 * = During programming, indicates that the code cannot be memorised because it transmits the "certificate"
- 4 * = Output in "Mode 2" not managed on control unit

5 * = During the deletion procedure, indicates that the code has been deleted

5 * = "Certificate" with lower priority than the admissible level

6 * = Code synchronisation failure

Long flashes > RED

1 * = Non-original code block

2 * = Code with lower priority than the authorised level

Short flashes > RED

1 * = "In vicinity" programming block

1 * = "Certificate" memorisation block

2 * = Memory block (PIN entry)

Long flashes > ORANGE

1 * = (on start-up, after a few green flashes) indicates the presence of two-way transmitters

Short flashes > ORANGE

2 * = Indicates activation of block programming (on start-up)

Nice